

Schottky Diodes

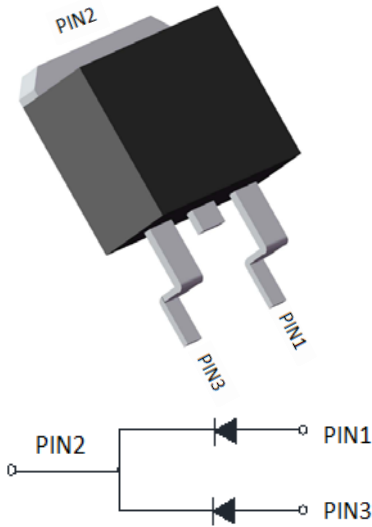

Features

- High frequency operation
- High purity, high temperature epoxy encapsulation for enhanced mechanical strength and moisture resistance
- Guard ring for enhanced ruggedness and long term reliability
- Meets MSL level 1, per J-STD-020, LF maximum peak of 260°C

Typical Applications

Typical applications are in switching power supplies, converters, freewheeling diodes, and reverse battery protection.

Mechanical Data

- **Package:** TO-263
Molding compound meets UL 94 V-0 flammability rating, RoHS-compliant
- **Terminals:** Tin plated leads, solderable per J-STD-002 and JESD22-B102
- **Polarity:** As marked

■Maximum Ratings (T_a=25°C Unless otherwise specified)

PARAMETER	SYMBOL	UNIT	MBRB20100CT	MBRB20150CT	MBRB20200CT
Device marking code			MBRB20100CT	MBRB20150CT	MBRB20200CT
Repetitive Peak Reverse Voltage	VRRM	V	100	150	200
Average Rectified Output Current @60Hz sine wave, R-load, T _a =25°C	I _O	A	20		
Surge(Non-repetitive)Forward Current @60Hz half sine-wave, 1 cycle, T _a =25°C	IFSM	A	150		
Current Squared Time @1ms≤t<8.3ms T _j =25°C,	I ² t	A ² s	94		
Storage Temperature	T _{stg}	°C	-55 ~ +175		
Junction Temperature	T _j	°C	-55 ~ +175		

■Electrical Characteristics (T_a=25°C Unless otherwise specified)

PARAMETER	SYMBOL	UNIT	TEST CONDITIONS	MBRB20100CT	MBRB20150CT	MBRB20200CT
Maximum instantaneous forward voltage drop per diode	V _{FM}	V	I _{FM} =10.0A	0.8	0.85	0.9
Maximum DC reverse current at rated DC blocking voltage per diode	I _{RRM1}	mA	V _{RM} =V _{RRM} T _a =25°C	0.1		
	I _{RRM2}		V _{RM} =V _{RRM} T _a =125°C	20		

Note1:Pulse test:300uS pulse width,1% duty cycle

Note2:Pulse test:pulse width 40mS



MBRB20100CT THRU MBRB20200CT-F2-W5094

■ Thermal Characteristics (T_a=25°C Unless otherwise specified)

PARAMETER		SYMBOL	UNIT	MBRB20100CT	MBRB20150CT	MBRB20200CT
Thermal Resistance	Between junction and case	R _{θJ-c}	°CW	2.0		

■ Ordering Information (Example)

PREFERRED P/N	UNIT WEIGHT(g)	MINIMUM PACKAGE(pcs)	INNER BOX QUANTITY(pcs)	OUTER CARTON QUANTITY(pcs)	DELIVERY MODE
MBRB20100CT THRU MBRB20200CT	Approximate 1.43	800	1600	8000	Reel

■ Characteristics (Typical)

FIG1: I_o -T_c Curve

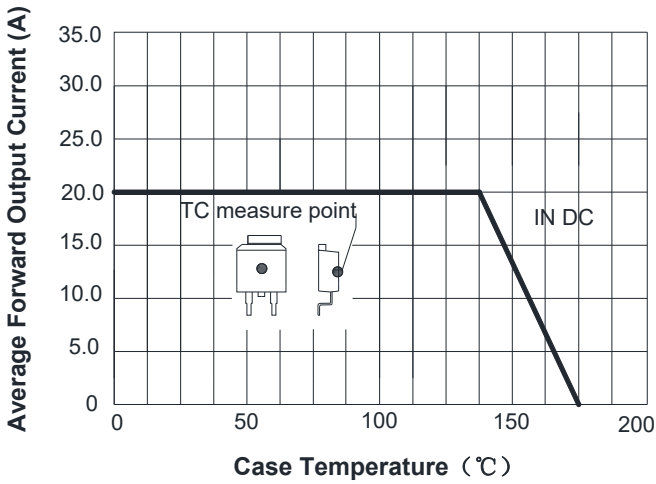

FIG2: Surge Forward Current Capability

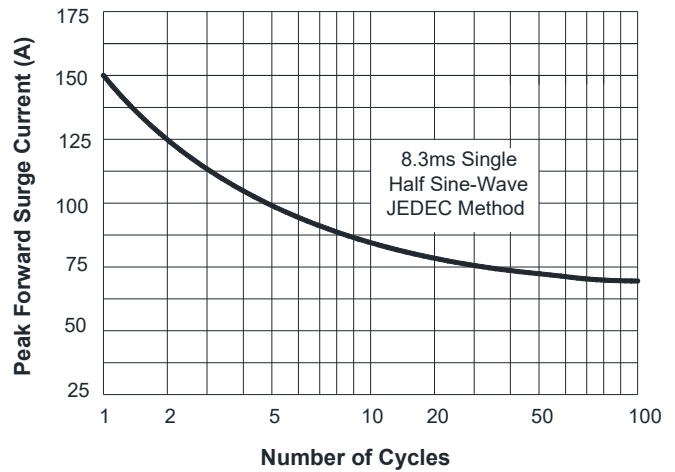

FIG3: Forward Voltage

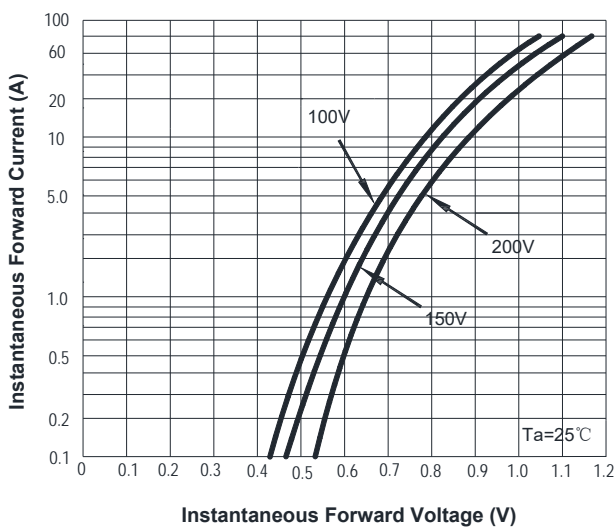
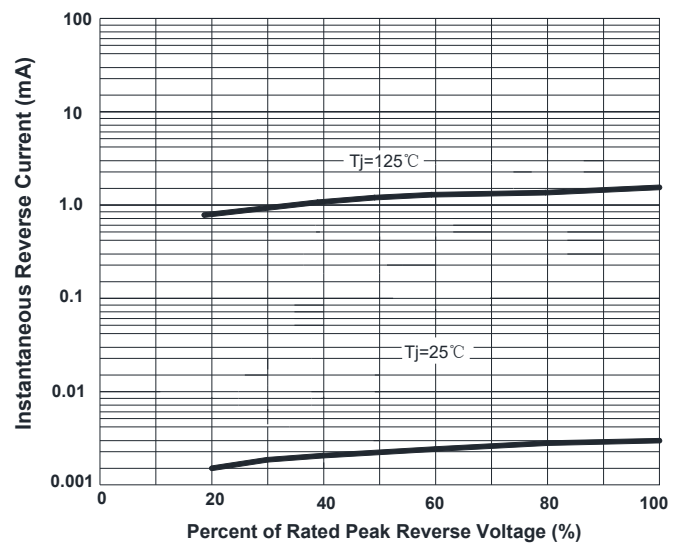

FIG4: Instantaneous Reverse Characteristics





MBRB20100CT THRU MBRB20200CT-F2-W5094

■ Outline Dimensions

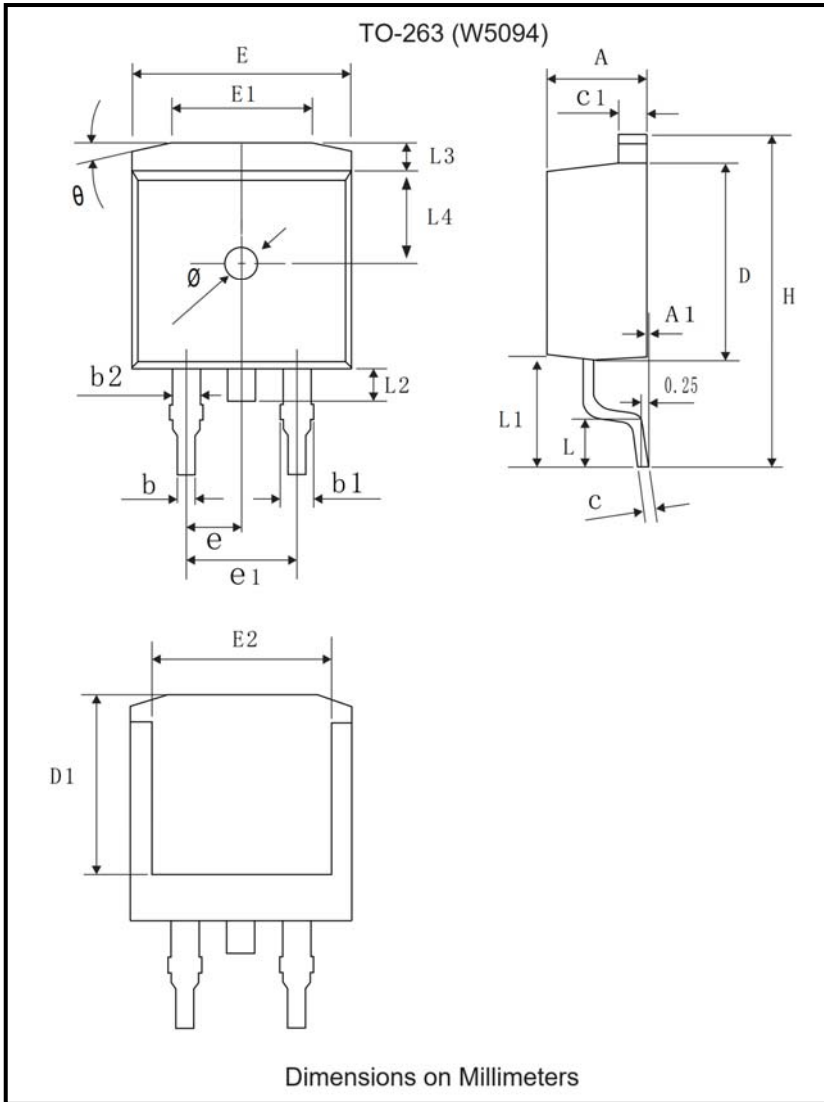

TO-263		
Dim	Min	Max
A	4.30	4.70
A1	0.00	0.25
b	0.70	0.90
B1	1.17	1.37
B2	1.17	1.37
C	0.40	0.60
C1	1.25	1.35
D	9.00	9.20
D1	8.00	8.20
H	14.9	15.5
E	9.80	10.2
E1	6.30	6.50
E2	7.90	8.10
e1	4.93	5.23
L	1.85	2.45
L1	4.45	4.85
L2	1.30	1.70
L3	1.15	1.35
L4	4.50	4.60
Ø	1.5 REF	
e	2.54 BSC	
θ	13°TYP	

■ Suggested Pad Layout

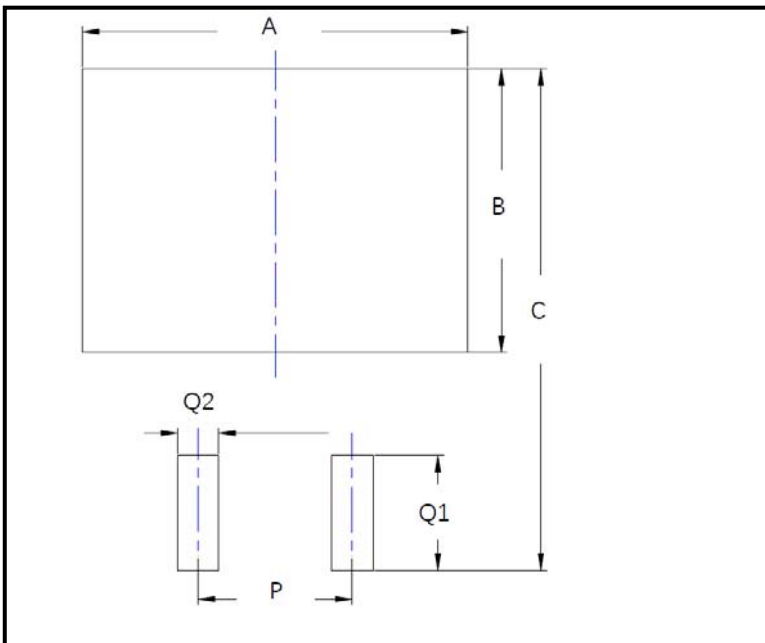

Dim	Millimeters
A	12.7
B	9.4
C	16.6
P	5.08
Q1	3.8
Q2	1.35



Disclaimer

The information presented in this document is for reference only. Yangzhou Yangjie Electronic Technology Co., Ltd. reserves the right to make changes without notice for the specification of the products displayed herein to improve reliability, function or design or otherwise.

The product listed herein is designed to be used with ordinary electronic equipment or devices, and not designed to be used with equipment or devices which require high level of reliability and the malfunction of which would directly endanger human life (such as medical instruments, transportation equipment, aerospace machinery, nuclear-reactor controllers, fuel controllers and other safety devices), Yangjie or anyone on its behalf, assumes no responsibility or liability for any damages resulting from such improper use of sale.

This publication supersedes & replaces all information previously supplied. For additional information, please visit our website [http:// www.21yangjie.com](http://www.21yangjie.com) , or consult your nearest Yangjie's sales office for further assistance.